

JVC

SERVICE MANUAL

COLOR TELEVISION

BASIC CHASSIS

GF2

AV-N29101

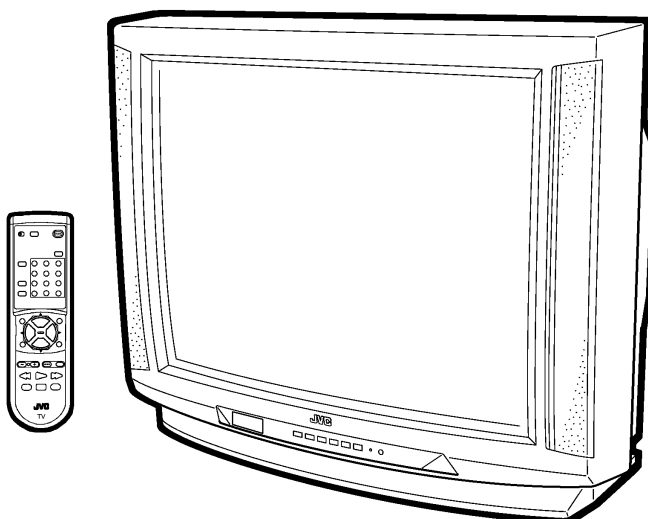

CONTENTS

■ SPECIFICATIONS	2
■ SAFETY PRECAUTIONS	3
■ FEATURES	4
★ INSTRUCCIONES DE OPERACIÓN (APPENDIX)	1-1
■ FUNCTIONS	5
■ SPECIFIC SERVICE INSTRUCTIONS	6
■ SERVICE ADJUSTMENTS	11
★ STANDARD CIRCUIT DIAGRAM (APPENDIX)	2-1
■ PARTS LIST	27

SPECIFICATIONS

Items	Contents	
Dimensions (W × H × D)	30-1/4" × 26-1/4" × 21-1/2" / (76.8cm × 66.7cm × 54.7cm)	
Mass	35.5kg	
TV System and Color system	TV RF System CCIR(M) Color System NTSC Sound System BTSC (Multi Channel Sound)	
TV Receiving Channels and Frequency	VL Band (02~06) 54MHz~88MHz VH Band (07~13) 174MHz~216MHz UHF Band (14~69) 470MHz~806MHz	
CATV Receiving Channels and Frequency	Low Band (02~06) High Band (07~13) Mid Band (14~22) Super Band (23~36) Hyper Band (37~64) Ultra Band (65~94, 100~125) Sub Mid Band (01, 96~99) } (54MHz~804MHz)	
TV/CATV Total Channel	180 Channels	
Intermediate Frequency	45.75 MHz	
Video IF Carrier	41.25 MHz (4.5MHz)	
Sound IF Carrier	41.25 MHz (4.5MHz)	
Color Sub Carrier	3.58 MHz	
Power Input	120V AC, 60Hz	
Power Consumption	125W	
Picture Tube	29" (74cm) measured diagonally, Full Square	
High Voltage	29kV ± 1.3kV (at zero beam current)	
Speaker	2" × 4-3/4" / 5 × 12cm Oblong type × 2	
Audio Power Output	5W+5W	
INPUT (Front input terminal is the bridge connection with Input 2 terminal)	1	2
S-Video	Y: 1Vp-p positive (negative sync provided, when terminated with 75 Ω) C: 0.286Vp-p (burst signal, when terminated with 75 Ω)	—————
Video	1Vp-p 75 Ω (RCA pin jack)	←—————
Audio	500mVrms (-4dBs), High Impedance (RCA pin jack)	←—————
Audio Output (Variable / Fix : Selectable)	Variable : More than 0~1550mVrms (+6dBs) Low Impedance (400Hz when modulated 100%) (RCA pin jack) Fix : 500mVrms(-4dBs) Low Impedance (400Hz when modulated 100%) (RCA pin jack)	
AV Compu link EX Input	3.5mm mini jack	
Antenna terminal	75 Ω (VHF/UHF) Terminal, F-Type Connector	
Remote Control Unit	RM-C381-1A (AA/R6/UM-3 battery × 2)	

Design & specifications are subject to change without notice.

SAFETY PRECAUTIONS

- The design of this product contains special hardware, many circuits and components specially for safety purposes. For continued protection, no changes should be made to the original design unless authorized in writing by the manufacturer. Replacement parts must be identical to those used in the original circuits. Service should be performed by qualified personnel only.
- Alterations of the design or circuitry of the products should not be made. Any design alterations or additions will void the manufacturer's warranty and will further relieve the manufacturer of responsibility for personal injury or property damage resulting therefrom.
- Many electrical and mechanical parts in the products have special safety-related characteristics. These characteristics are often not evident from visual inspection nor can the protection afforded by them necessarily be obtained by using replacement components rated for higher voltage, wattage, etc. Replacement parts which have these special safety characteristics are identified in the parts list of Service manual. **Electrical components having such features are identified by shading on the schematics and by (Δ) on the parts list in Service manual.** The use of a substitute replacement which does not have the same safety characteristics as the recommended replacement part shown in the parts list of Service manual may cause shock, fire, or other hazards.
- Use isolation transformer when hot chassis.**
The chassis and any sub-chassis contained in some products are connected to one side of the AC power line. An isolation transformer of adequate capacity should be inserted between the product and the AC power supply point while performing any service on some products when the HOT chassis is exposed.
- Don't short between the LIVE side ground and ISOLATED (NEUTRAL) side ground or EARTH side ground when repairing.**
Some model's power circuit is partly different in the GND. The difference of the GND is shown by the LIVE : (\perp) side GND, the ISOLATED(NEUTRAL) : (\swarrow) side GND and EARTH : (\oplus) side GND. Don't short between the LIVE side GND and ISOLATED(NEUTRAL) side GND or EARTH side GND and never measure with a measuring apparatus (oscilloscope etc.) the LIVE side GND and ISOLATED(NEUTRAL) side GND or EARTH side GND at the same time.
If above note will not be kept, a fuse or any parts will be broken.
- If any repair has been made to the chassis, it is recommended that the B1 setting should be checked or adjusted (See ADJUSTMENT OF B1 POWER SUPPLY).
- The high voltage applied to the picture tube must conform with that specified in Service manual. Excessive high voltage can cause an increase in X-Ray emission, arcing and possible component damage, therefore operation under excessive high voltage conditions should be kept to a minimum, or should be prevented. If severe arcing occurs, remove the AC power immediately and determine the cause by visual inspection (incorrect installation, cracked or melted high voltage harness, poor soldering, etc.). To maintain the proper minimum level of soft X-Ray emission, components in the high voltage circuitry including the picture tube must be the exact replacements or alternatives approved by the manufacturer of the complete product.
- Do not check high voltage by drawing an arc. Use a high voltage meter or a high voltage probe with a VTVM. Discharge the picture tube before attempting meter connection, by connecting a clip lead to the ground frame and connecting the other end of the lead through a 10k Ω 2W resistor to the anode button.
- When service is required, observe the original lead dress. Extra precaution should be given to assure correct lead dress in the high voltage circuit area. Where a short circuit has occurred, those components that indicate evidence of overheating should be replaced. Always use the manufacturer's replacement components.

10. Isolation Check

(Safety for Electrical Shock Hazard)

After re-assembling the product, always perform an isolation check on the exposed metal parts of the cabinet (antenna terminals, video/audio input and output terminals, Control knobs, metal cabinet, screw heads, earphone jack, control shafts, etc.) to be sure the product is safe to operate without danger of electrical shock.

(1) Dielectric Strength Test

The isolation between the AC primary circuit and all metal parts exposed to the user, particularly any exposed metal part having a return path to the chassis should withstand a voltage of 1100V AC (r.m.s.) for a period of one second.

(. . . Withstand a voltage of 1100V AC (r.m.s.) to an appliance rated up to 120V, and 3000V AC (r.m.s.) to an appliance rated 200V or more, for a period of one second.)

This method of test requires a test equipment not generally found in the service trade.

(2) Leakage Current Check

Plug the AC line cord directly into the AC outlet (do not use a line isolation transformer during this check.). Using a "Leakage Current Tester", measure the leakage current from each exposed metal part of the cabinet, particularly any exposed metal part having a return path to the chassis, to a known good earth ground (water pipe, etc.). Any leakage current must not exceed 0.5mA AC (r.m.s.).

However, in tropical area, this must not exceed 0.2mA AC (r.m.s.).

● Alternate Check Method

Plug the AC line cord directly into the AC outlet (do not use a line isolation transformer during this check.). Use an AC voltmeter having 1000 ohms per volt or more sensitivity in the following manner. Connect a 1500 Ω 10W resistor paralleled by a 0.15 μ F AC-type capacitor between an exposed metal part and a known good earth ground (water pipe, etc.). Measure the AC voltage across the resistor with the AC voltmeter. Move the resistor connection to each exposed metal part, particularly any exposed metal part having a return path to the chassis, and measure the AC voltage across the resistor. Now, reverse the plug in the AC outlet and repeat each measurement. Any voltage measured must not exceed 0.75V AC (r.m.s.). This corresponds to 0.5mA AC (r.m.s.). However, in tropical area, this must not exceed 0.3V AC (r.m.s.). This corresponds to 0.2mA AC (r.m.s.).

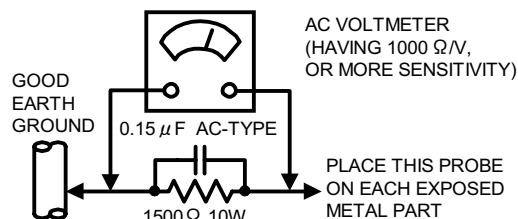

FEATURES

- New chassis design enables use of a main board with simplified circuitry.
- Digital comb filter Improved picture quality.
- Full-square CRT (cathode ray tube) reproduces fine textured picture in every detail.
- Closed-caption broadcasts can be viewed.
- With AUDIO. VIDEO INPUT terminal.
- I²C bus control utilizes single chip ICs.
- S-VIDEO input terminal for taking best advantage of Super VHS.
- Variable / Fix audio output terminal.
- With AV COMPU LINK EX terminal.

■ SYSTEM BLOCK DIAGRAM

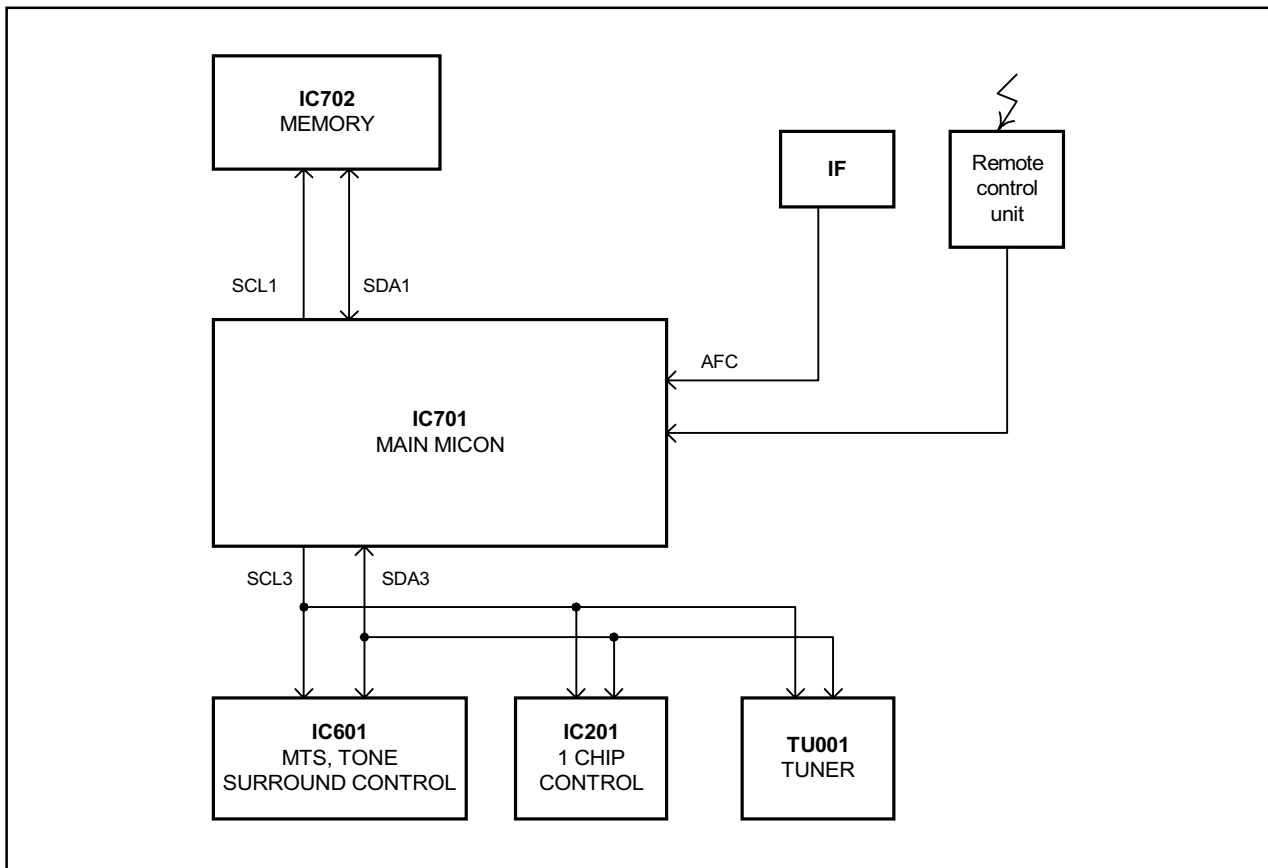

FUNCTIONS

REMOTE CONTROL UNIT (RM-C381-1A)

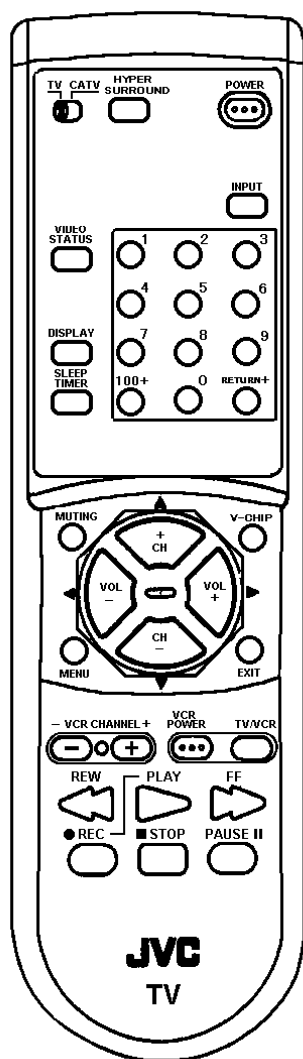

FRONT PANEL

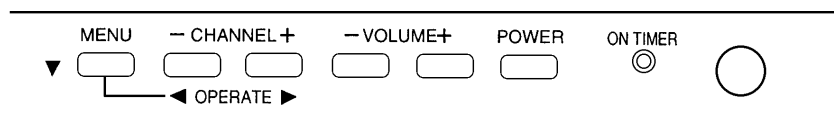

FRONT TERMINAL

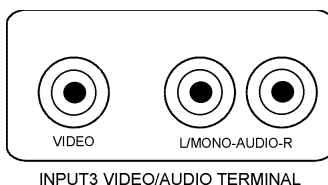

REAR PANEL

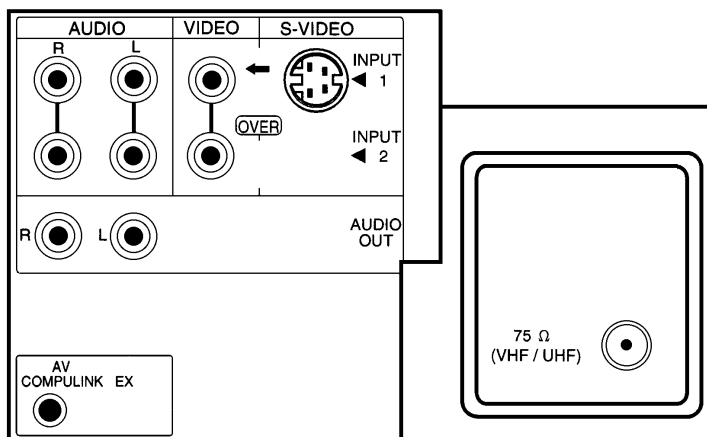

SPECIFIC SERVICE INSTRUCTIONS

DISASSEMBLY PROCEDURE

REMOVE THE REAR COVER

- Unplug the power plug.
1. Remove the **12** screws marked **(A)** as shown in Fig.2.
 2. Remove the rear cover toward you.

* When reinstalling the rear cover, carefully push it inward after inserting the chassis into the rear cover groove.

REMOVING THE CHASSIS

- After removing the rear cover.
1. Slightly raise the both sides of the chassis by hand and remove the **2** claws under the both sides of the chassis from the front cabinet.
 2. As shown in the Fig.2, withdraw the chassis backward along the rail in the arrow direction marked **(B)**.
(If necessary, take off the wire clamp, connector's etc.)

* When conducting a check with power supplied, be sure to confirm that the CRT earth wire is connected to the CRT SOCKET PWB and the MAIN PWB.

REMOVING THE TERMINAL BOARD

- After removing the rear cover.
1. As shown in Fig.2, remove the **3** screws marked **(C)**.
 2. As shown in Fig.1, after removing the claw marked **(D)** in the direction of arrow mark.
 3. When you pull out the TERMINAL BOARD in the direction of arrow marked **(E)** as shown in Fig.1, it can be removed.

REMOVING THE FRONT CONTROL PW BOARD

- After removing the rear cover and chassis.
1. As shown in Fig.2, remove the **3** screws marked **(F)**.
 2. Then remove the FRONT CONTROL PWB.

REMOVING THE FRONT AV IN PW BOARD

- After removing the rear cover and chassis.
1. As shown in Fig.2, remove the **2** screws marked **(G)**.
 2. Then remove the FRONT AV IN PWB.

REMOVING THE SPEAKER

- After removing the rear cover and chassis.
1. As shown in Fig.2, remove the **4** screws marked **(H)**.
 2. Follow the same steps when removing the other hand speaker.

CHECKING THE MAIN PW BOARD

1. To check the backside of the MAIN PW Board.
 - (1) Pull out the chassis. (Refer to REMOVING THE CHASSIS).
 - (2) Erect the chassis vertically so that you can easily check the backside of the MAIN PW Board.

[CAUTION]

- When erecting the chassis, be careful so that there will be no contacting with other PWB.
- Before turning on power, make sure that the CRT earth wire and other connectors are properly connected.

WIRE CLAMPING AND CABLE TYING

1. Be sure to clamp the wire.
2. Never remove the cable tie used for tying the wires together. Should it be inadvertently removed, be sure to tie the wires with a new cable tie.

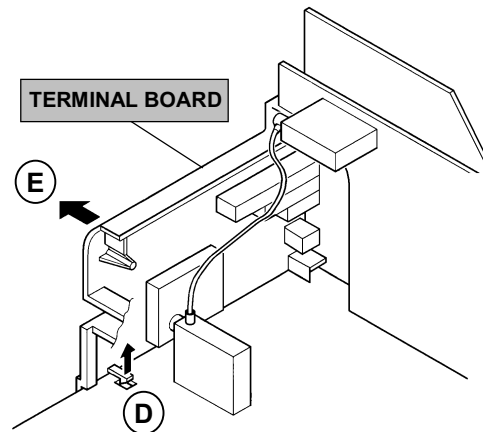

Fig. 1

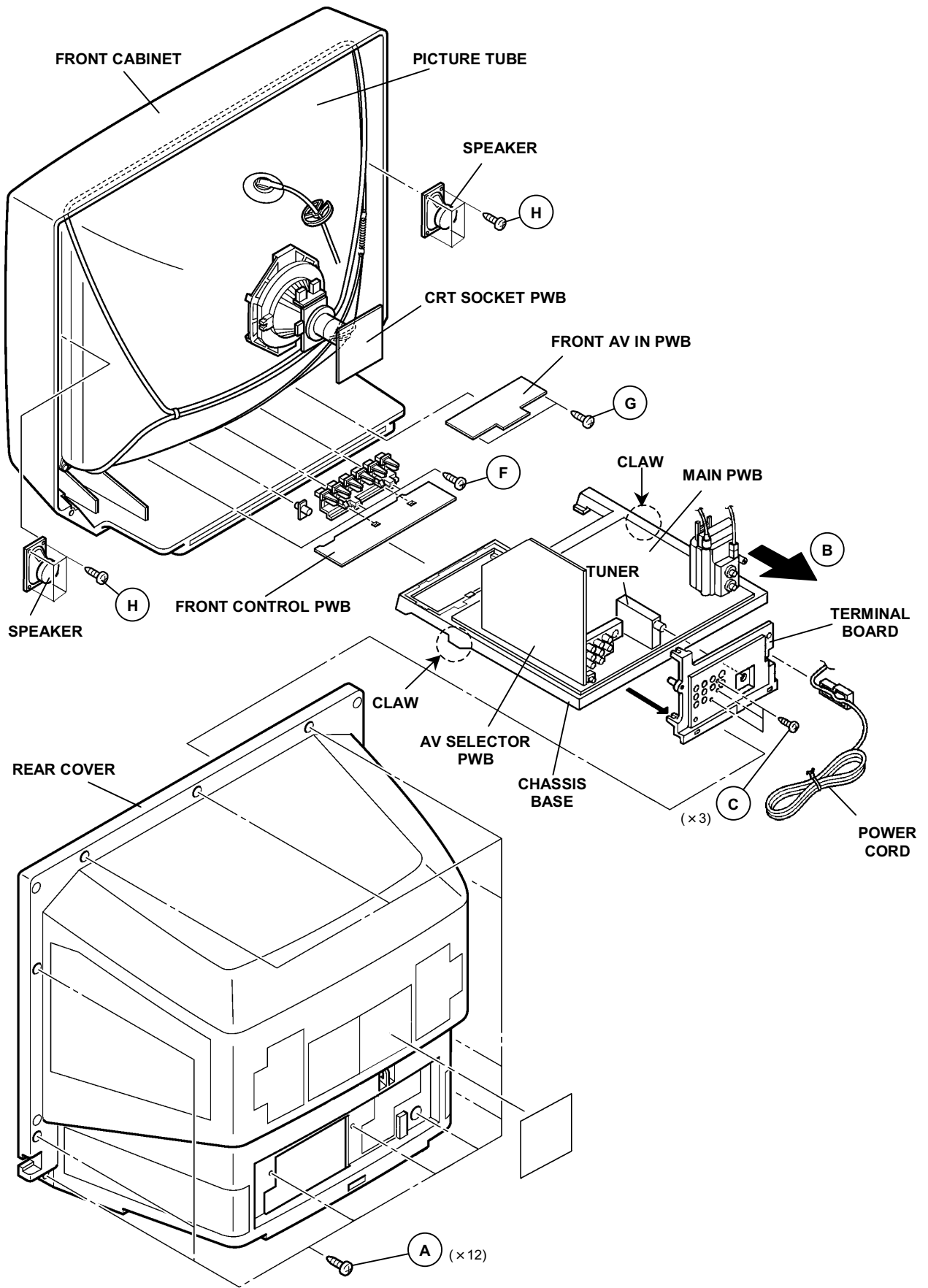

Fig. 2

MEMORY IC REPLACEMENT

1. Memory IC

This model uses a memory IC.

This memory IC stores data for proper operation of the video and deflection circuits.

When replacing, be sure to use an IC containing this (initial value) data.

2. Memory IC replacement procedure

Procedure	Screen display										
<p>(1) Power off Switch off the power and disconnect the power cord from the outlet.</p>											
<p>(2) Replace the memory IC Initial value must be entered into the new IC.</p>											
<p>(3) Power on Connect the power cord to the outlet and switch on the power.</p>											
<p>(4) System constant check and setting * It must not adjustment</p> <ol style="list-style-type: none"> 1) Press SLEEP TIMER key and, while the indication of "SLEEP TIMER 0 MIN." is being displayed, press DISPLAY key and VIDEO STATUS key on the remote control unit simultaneously. 2) The SERVICE MENU screen of Fig.1 is displayed. 3) While the SERVICE MENU is displayed, again simultaneously press the DISPLAY and VIDEO STATUS keys to display the Fig.2 SYSTEM CONSTANT screen. 4) Refer to the SYSTEM CONSTANT table and check the setting items. Where these differ, select the setting item with the MENU UP/DOWN key and adjust the setting with the MENU LEFT/RIGHT keys. (The letters of the selected item are displayed in yellow.) 5) After adjusting, release the MENU LEFT/RIGHT key to store the setting value. 6) Press the EXIT key twice to return the normal screen. 	<div data-bbox="935 902 1302 1173" style="border: 1px solid black; padding: 5px; margin-bottom: 10px;"> <p style="text-align: center;">SERVICE MENU</p> <table style="width: 100%; border-collapse: collapse;"> <tr> <td style="width: 50%;">PICTURE</td> <td style="width: 50%;">SOUND</td> </tr> <tr> <td>THEATER</td> <td>OTHERS</td> </tr> <tr> <td>LOW LIGHT</td> <td>HIGH LIGHT</td> </tr> <tr> <td>RF AFC</td> <td>I2C BUS CTRL</td> </tr> <tr> <td>VCO (CW)</td> <td></td> </tr> </table> <p>SELECT BY ▲ ▼</p> <p>OPERATE BY ◀ ▶ EXIT BY ⓧ</p> </div> <p style="text-align: center;">Fig.1</p> <div data-bbox="930 1263 1297 1534" style="border: 1px solid black; padding: 5px;"> <p style="text-align: center;">SYSTEM CONSTANT</p> <p>MODEL : XX-XXXX</p> <p>CCD : YES</p> <p>BBE : NO</p> <p>V-CHIP : YES</p> <p>CAN V-CHIP : NO</p> <p>XXXXXXXXXX XXX</p> <p>SELECT BY ▲ ▼</p> <p>OPERATE BY ◀ ▶ EXIT BY ⓧ</p> </div> <p style="text-align: center;">Fig.2</p>	PICTURE	SOUND	THEATER	OTHERS	LOW LIGHT	HIGH LIGHT	RF AFC	I2C BUS CTRL	VCO (CW)	
PICTURE	SOUND										
THEATER	OTHERS										
LOW LIGHT	HIGH LIGHT										
RF AFC	I2C BUS CTRL										
VCO (CW)											
<p>(5) Receive channel setting Refer to the OPERATING INSTRUCTIONS (USER'S GUIDE) and set the receive channels (Channels Preset) as described.</p>											
<p>(6) User settings Check the user setting items according to Table 2. Where these do not agree, refer to the OPERATING INSTRUCTIONS (USER'S GUIDE) and set the items as described.</p>											
<p>(7) SERVICE MENU setting Verify what to set in the SERVICE MENU, and set whatever is necessary. (Fig.1) Refer to the SERVICE ADJUSTMENT for setting.</p>											

TABLE 1 (System Constant setting)

Setting item	Setting constant	Setting value
MODEL		AV-32120
CCD		YES
BBE		NO
V-CHIP		YES
CAN V-CHIP		NO

TABLE 2 (User setting)

Setting item	Setting value	Setting item	Setting value
1. Use remote controller keys POWER OFF CHANNEL CH-02 VOLUME Proper sound volume TV/VIDEO TV HYPER SURROUND OFF		DISPLAY OFF VIDEO STATUS ESTANDAR SLEEP TIMER 0	
2. Settings of MENU with remote control keys TINTE CENTER COLOR CENTER CONTRASTE CENTER BRILLO CENTER DETALLE CENTER PANTALLA AZUL SI FIJAR VIDEO STATUS ALL CENTER GRAVES CENTER AGUDOS CENTER BALANCE CENTER MTS ESTEREO AJUSTE DEL RELOJ Unnecessary to set TEMPORIZADOR NO		ALTAVOCES SI SALIDA AUDIO FIX IDIOMA ESP. SUBTITULOS OCULTOS NODO : NO AUTOPROGRAMACION MODO : TV LISTA DE CANALES Unnecessary to set BLOQUEO DE CANAL Unnecessary to set	

REPLACEMENT OF CHIP COMPONENT

■ CAUTIONS

1. Avoid heating for more than 3 seconds.
2. Do not rub the electrodes and the resist parts of the pattern.
3. When removing a chip part, melt the solder adequately.
4. Do not reuse a chip part after removing it.

■ SOLDERING IRON

1. Use a high insulation soldering iron with a thin pointed end of it.
2. A 30w soldering iron is recommended for easily removing parts.

■ REPLACEMENT STEPS

1. How to remove Chip parts

◆ Resistors, capacitors, etc

- (1) As shown in the figure, push the part with tweezers and alternately melt the solder at each end.

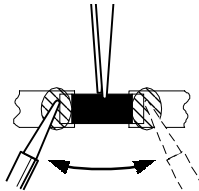

- (2) Shift with tweezers and remove the chip part.

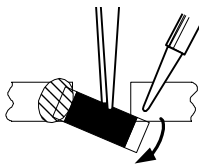

◆ Transistors, diodes, variable resistors, etc

- (1) Apply extra solder to each lead.

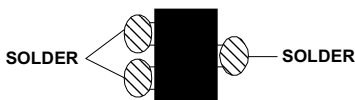

- (2) As shown in the figure, push the part with tweezers and alternately melt the solder at each lead. Shift and remove the chip part.

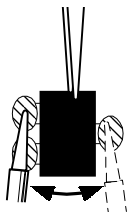

Note : After removing the part, remove remaining solder from the pattern.

2. How to install Chip parts

◆ Resistors, capacitors, etc

- (1) Apply solder to the pattern as indicated in the figure.

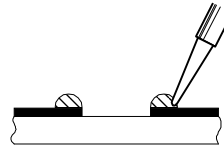

- (2) Grasp the chip part with tweezers and place it on the solder. Then heat and melt the solder at both ends of the chip part.

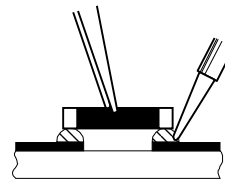

◆ Transistors, diodes, variable resistors, etc

- (1) Apply solder to the pattern as indicated in the figure.
- (2) Grasp the chip part with tweezers and place it on the solder.
- (3) First solder lead **A** as indicated in the figure.

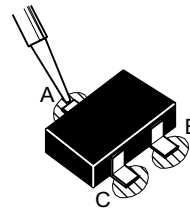

- (4) Then solder leads **B** and **C**.

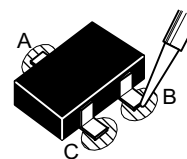

SERVICE ADJUSTMENTS

ADJUSTMENT PREPARATION:

1. You can make the necessary adjustments for this unit with either the remote control unit or with the adjustment equipment and parts as given below.
2. Adjustment with the remote control unit is made on the basis of the initial setting values, however, the new setting values which set the screen to its optimum condition may differ from the initial settings.
3. Make sure that AC power is turned on correctly.
4. Turn on the power for the set and test equipment before use, and start the adjustment procedures after waiting at least 30 minutes.
5. Unless otherwise specified, prepare the most suitable reception or input signal for adjustment.
6. Never touch any adjustment parts, which are not specified in the list for this adjustment-variable resistors, transformers, condensers, etc.
7. Presetting before adjustment.

Unless otherwise specified in the adjustment instructions, preset the following functions with the remote control unit.

● User mode setting position

(1) VIDEO STATUS	STANDARD
(2) HYPER SURROUND	OFF
(3) BASS, TREBLE, BALANCE	CENTER
(4) TINT, COLOR, PICTURE, BRIGHT, DETAIL	CENTER

MEASURING INSTRUMENT

1. DC voltmeter(or digital voltmeter)
2. Oscilloscope
3. Signal generator (Pattern generator) [NTSC]
4. Remote control unit
5. TV audio multiplex signal generator
6. Frequency counter

ADJUSTMENT ITEMS

- Check of B1 POWER SUPPLY
- IF VCO adjustment
- RF AGC adjustment
- FOCUS adjustment
- DEFLECTION adjustment
 - V. CENTER, V. SIZE, V. POSITION adjustment
 - H. WIDTH, SIDE PIN CORRECT and H. POSITION adjustment
- VIDEO / CHROMA adjustment
 - WHITE BALANCE (Low light) adjustment
 - WHITE BALANCE (High light) adjustment
 - SUB BRIGHT adjustment
 - SUB CONTRAST adjustment
 - SUB COLOR adjustment
 - SUB TINT adjustment
- MTS circuit adjustment
 - INPUT LEVEL check
 - STEREO VCO adjustment
 - SAP VCO adjustment
 - FILTER check
 - SEPARATION adjustment

ADJUSTMENT LOCATIONS

MAIN PWB ASS'Y

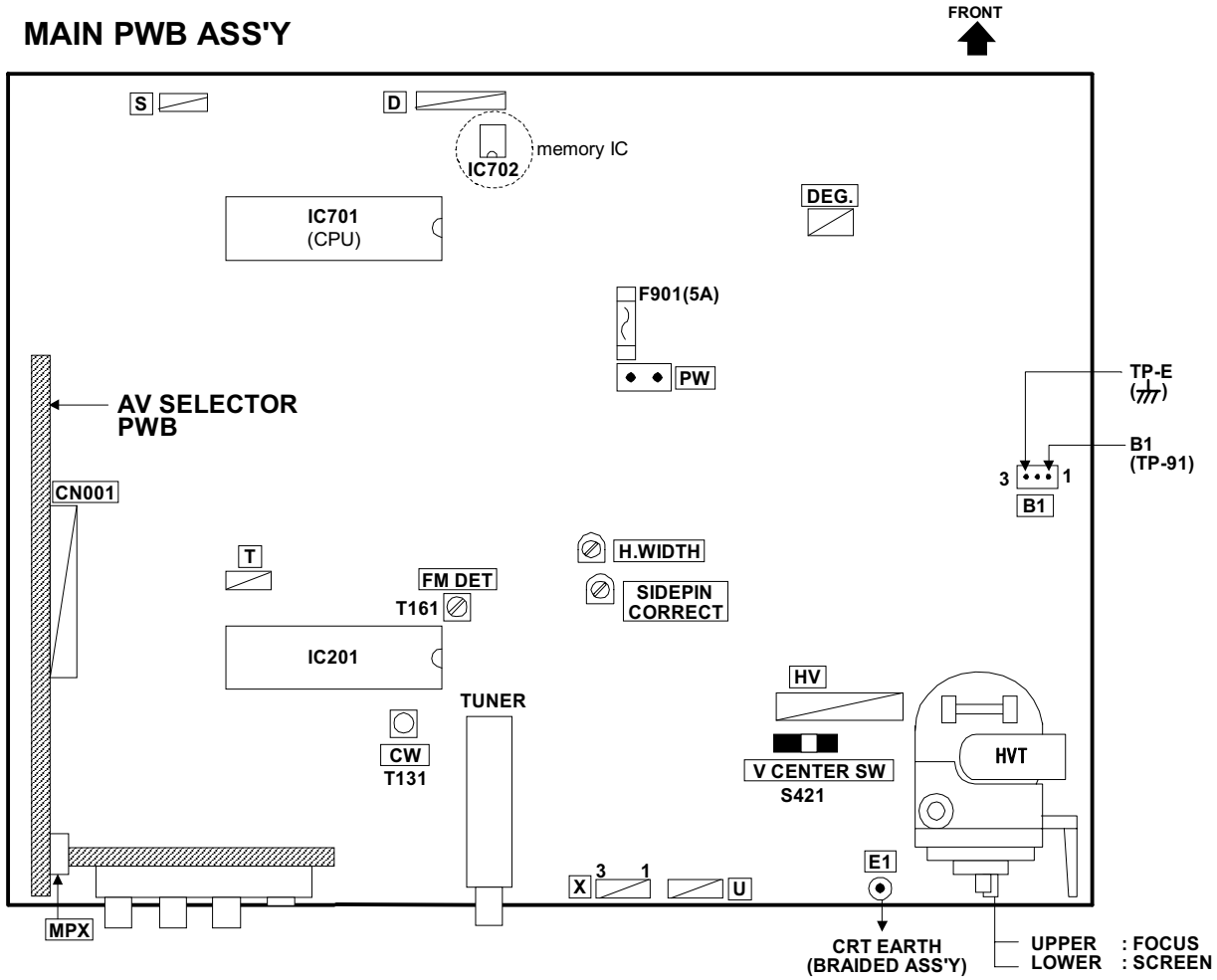

CRT SOCKET PWB ASS'Y

(SOLDER SIDE)

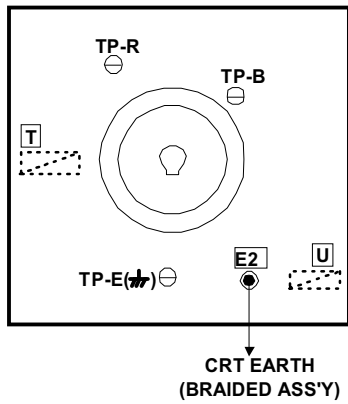

FRONT CONTROL PWB ASS'Y

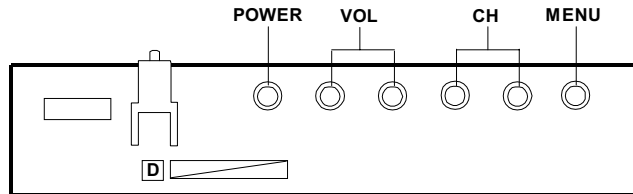

FRONT AV IN PWB ASS'Y

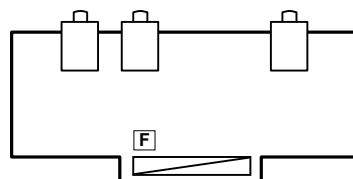

BASIC OPERATION OF SERVICE MENU

1. TOOL OF SERVICE MENU OPERATION

Operate the SERVICE MENU with the REMOTE CONTROL UNIT.

2. SERVICE MENU ITEMS

In general, basic setting (adjustments) items or verifications are performed in the SERVICE MENU.

- PICTURE This set the setting values (adjustment values) of the VIDEO/CHROMA and DEFLECTION circuits.
- SOUND This set the setting values (adjustment values) of the AUDIO circuit.
- THEATER This is used when the THEATER MODE is adjusted.
- OTHERS This is used when the OTHERS MODE is adjusted.
- LOW LIGHT This sets the setting values (adjustment values) of the WHITE BALANCE circuit.
- HIGH LIGHT This sets the setting values (adjustment values) of the WHITE BALANCE circuit.
- RF AFC This is used when the RF AFC MODE is verified. **[Do not adjust]**
- VCO (CW) This is used when the IF VCO is adjusted.
- I²C BUS CTRL This is used when ON/OFF of the I²C BUS CTRL is set. **[Fixed ON]**

3. Basic Operations of the SERVICE MENU

(1) How to enter the SERVICE MENU.

Press **SLEEP TIMER** key and, while the indication of "SLEEP TIMER 0 MIN." is being displayed, press **DISPLAY** key and **VIDEO STATUS** key on the remote control unit simultaneously to enter the **SERVICE MENU** screen ① shown in the next figure page.

(2) SERVICE MENU screen selection

Press the UP / DOWN key of the MENU to select any of the following items.

(The letters of the selected items are displayed in yellow.)

- | | |
|-------------|-----------------------------|
| ● PICTURE | ● SOUND |
| ● THEATER | ● OTHERS |
| ● LOW LIGHT | ● HIGH LIGHT |
| ● RF AFC | ● I ² C BUS CTRL |
| ● VCO (CW) | |

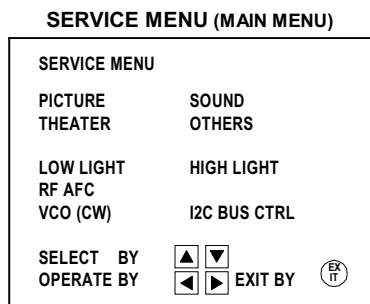

(3) Enter the any setting (adjustment) mode

● PICTURE, SOUND and OTHERS mode

- 1) If select any of PICTURE, SOUND or OTHERS items, and the LEFT / RIGHT key is pressed from SERVICE MENU (MAIN MENU), the screen ② will be displayed as shown in figure page later.
- 2) Then the UP / DOWN key is pressed, the PICTURE mode screen ③ or the SOUND mode screen ④ or the OTHERS mode screen ⑤ is displayed, and the PICTURE, SOUND or OTHERS setting can be performed.

● THEATER, LOW LIGHT, HIGH LIGHT, RF AFC, VCO (CW) and I²C BUS CTRL mode

- 1) If select any of THEATER / LOW LIGHT / HIGH LIGHT / RF AFC / VCO (CW) / I²C BUS CTRL items, and the LEFT / RIGHT key is pressed from SERVICE MENU (MAIN MENU), the screens ⑥ ⑦ ⑧ ⑨ ⑩ ⑪ will be displayed as shown in figure page later.
- 2) Then the settings or verifications can be performed.

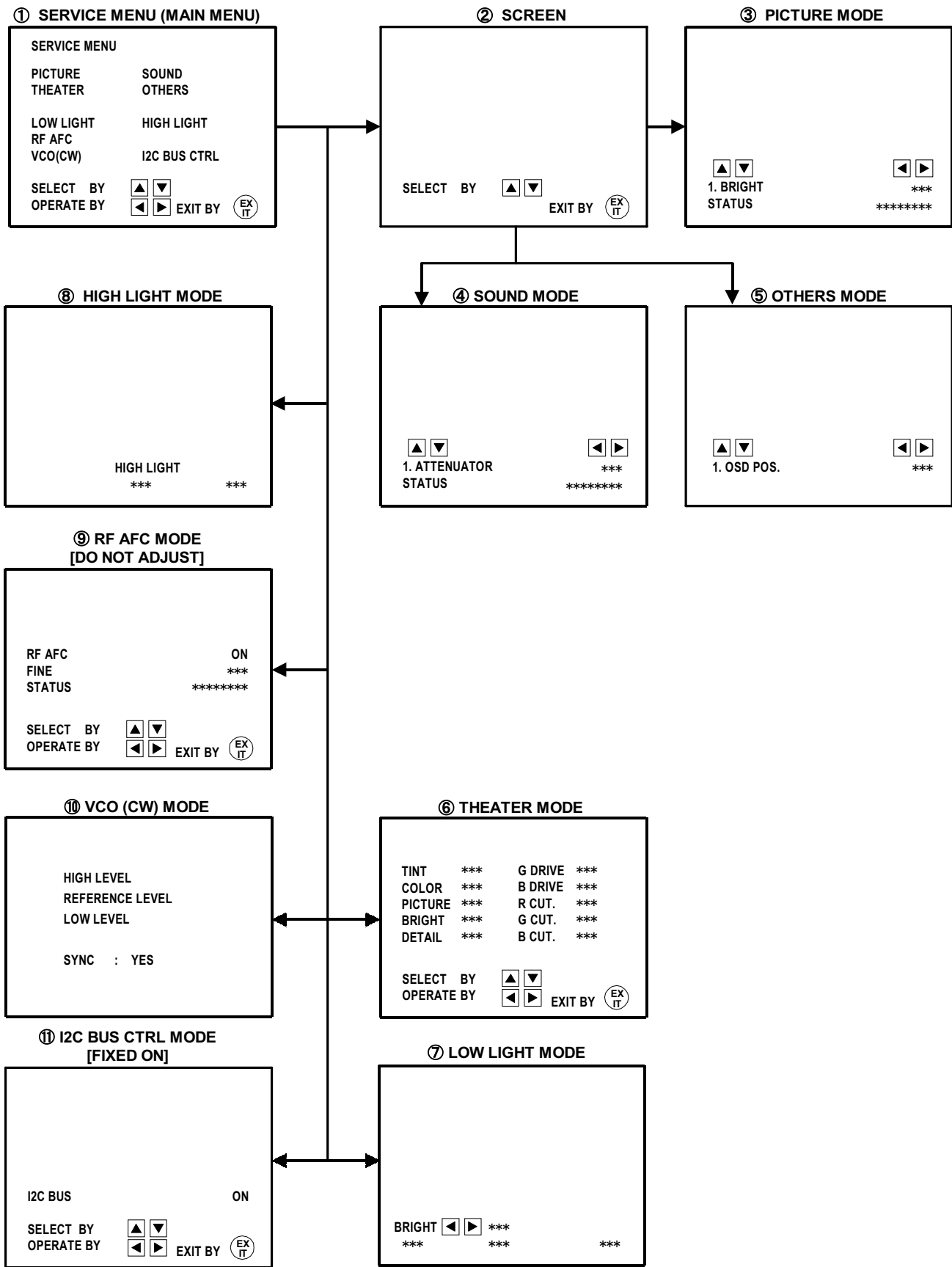

(4) Setting method

- 1) UP / DOWN key of the MENU
Select the SETTING ITEM.
- 2) LEFT / RIGHT key of the MENU
Setting (adjust) the SETTING VALUE of the SETTING ITEM.
When the key is released the SETTING VALUE will be stored (memorized).
- 3) EXIT key
Returns to the previous screen.

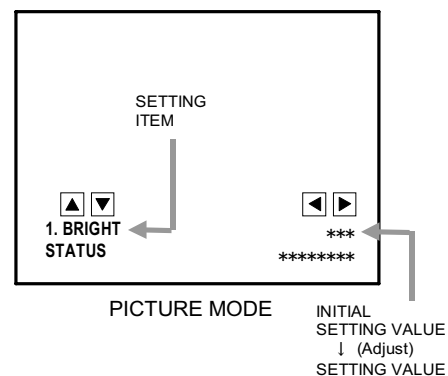

(5) Releasing SERVICE MENU

- 1) After returning to the SERVICE MENU upon completion of the setting (adjustment) work, press the EXIT key again.

- ★ The settings for LOW LIGHT and HIGH LIGHT are described in the WHITE BALANCE page of ADJUSTMENT.
- ★ The setting for VCO (CW) are described in the IF VCO page of ADJUSTMENT.

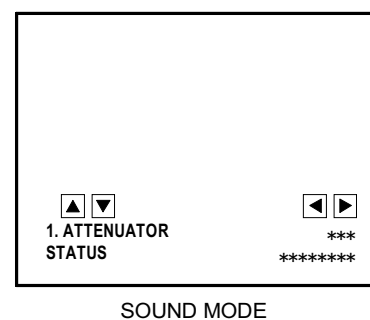

(The letters of the selected items are displayed in yellow.)

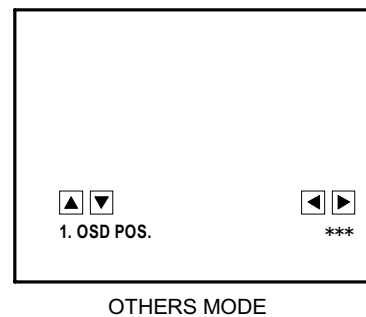
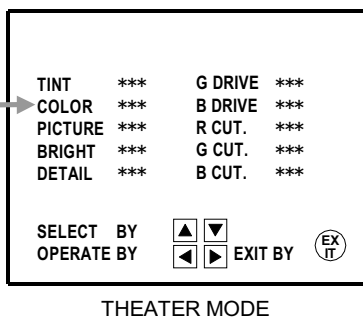

INITIAL SETTING VALUE OF SERVICE MENU

1. Adjustment of the SERVICE MENU is made on the basis of the initial setting values; however, the new setting values which set the screen in its optimum condition may differ from the initial setting.
2. Do not change the initial Setting Values of the Setting (Adjustment) items not listed in "ADJUSTMENT".

● PICTURE MODE

- ◇ The four setting items in the video mode No.8 EXT BRI., No.9 EXT PIC., No.12 EXT TINT and No.13 EXT COL OR are linked to the items in the TV MODE No.1 BRIGHT, No.2 PICTURE, No.6 TINT and No.7 COLOR, respectively. When the setting items in the TV mode are adjusted, the values in the setting items in the video mode are revised automatically to the same values in the TV mode. (The initial setting values given in () are off-set values.)
- ◇ When the four items (No.8, 9, 12 and 13) are adjusted in the video mode, the setting values in each item are revised independently.

No	Setting (Adjustment) item	Variable range	Initial setting value
1.	BRIGHT	000~127	064
2.	PICTURE	000~127	088
3.	WPS (WHITE PEAK SUPPRESSOR)	000 / 001	001
4.	TV DETAIL	000~063	040
5.	TV BPF (TV B.P.FILTER)	000 / 001	001
6.	TINT	000~127	067
7.	COLOR	000~127	047
8.	EXT BRIGHT	±025	(+001)
9.	EXT PICT.	±025	(±000)
10.	EXT DETAIL	000~063	038
11.	EXT BPF (EXT B.P.FILTER)	000 / 001	001
12.	EXT TINT	±025	(+002)
13.	EXT COLOR	±025	(+003)
14.	V SIZE	000~063	015
15.	V CENTER	000~007	000
16.	H POSITION	000~031	022
17.	H AFC	000 / 001	000
18.	BLANKING	000 / 001	000
19.	RF AGC	000~063	035
20.	PIF VCO	000~127	064

● SOUND MODE

No	Setting (Adjustment) item	Variable range	Initial setting value
1.	ATTENUATOR	000~063	050
2.	BALANCE	000~063	032
3.	NOISE DET.	000 / 001	001
4.	IN LEVEL (INPUT LEVEL)	000~063	027
5.	FH MONITOR	000 / 001	000
6.	STEREO VCO	000~063	023
7.	PILOT CAN. (PILOT CANCELER)	000 / 001	000
8.	FILTER	000~063	030
9.	LOW SEP. (LOW SEPARATION)	000~063	028
10.	HI SEP. (HIGH SEPARATION)	000~063	019
11.	5FH MON. (5FH MONITOR)	000 / 001	000
12.	SAP VCO	000~063	027
13.	IN GAIN	000 / 001	000
14.	FIL.OFFSET	±010	±000
15.	BBE BASS	±010	-001
16.	BBE TRE	±010	-001

● THEATER MODE

Setting (Adjustment) item	Variable range	Initial setting value
TINT	-20~+20	±00
COLOR	-20~+20	-02
PICTURE	-30~+20	-15
BRIGHT	-20~+20	±00
DETAIL	-15~+15	-03
G DRIVE	-99~+50	-25
B DRIVE	-99~+50	-72
R CUT. (R CUTOFF)	±10	±00
G CUT. (G CUTOFF)	±10	±00
B CUT. (B CUTOFF)	±10	±00

● OTHERS MODE

No.	Setting (Adjustment) item	Variable range	Initial setting value
1.	OSD POS.	000~007	000
2.	CCD POS. (CLOSED CAPTION DECODER POS.)	000~015	002
3.	EOSEL	000 / 001	000
4.	F1 FIELD	000 / 001	000
5.	F1 LINE21	000~015	008
6.	F2 LINE21	000~015	008
7.	OSD STABI	000 / 001	000
8.	SYNC SEP.	000 / 001	001
9.	MENU COLOR	-030~±000	-010
10.	MENU PICT	-030~±000	-012
11.	MENU BRI	-030~±000	-012
12.	TU1 FM TRAP	000 / 001	000
13.	TU2 FM TRAP	000 / 001	000

● LOW LIGHT MODE

Setting (Adjustment) item	Variable range	Initial setting value
R CUTOFF	000~255	020
G CUTOFF	000~255	020
B CUTOFF	000~255	020

● HIGH LIGHT MODE

Setting (Adjustment) item	Variable range	Initial setting value
G DRIVE	000~255	128
B DRIVE	000~255	128

● RF AFC MODE

Setting (Adjustment) item	Variable range	Initial setting value
RF AFC	ON/OFF	ON (DO NOT)
FINE	-77~+77	± × × (ADJUST)

● I2C BUS CTRL MODE

Setting (Adjustment) item	Variable range	Initial setting value
I2C BUS	ON/OFF	[Fixed ON] [DO NOT ADJUST]

■ ADJUSTMENTS

B1 POWER SUPPLY

Item	Measuring instrument	Test point	Adjustment part	Description
Check of B1 POWER SUPPLY	DC Voltmeter	B1 ([B1] Connector ① pin) (TP-91) TP-E(↔) ([B1] Connector ③ pin)		<ol style="list-style-type: none"> 1. Receive a black-and-white signal. (Color off) 2. Connect the DC Voltmeter to [B1] connector ① pin (TP-91) and TP-E(↔) (B1 connector ③ pin). 3. Confirm that the voltage is DC134V±2V.

ADJUSTMENT OF IF. VCO

Item	Measuring instrument	Test point	Adjustment part	Description
IF VCO adjustment	Signal generator		CW TRANSF. [VCO(CW)] MODE	<ul style="list-style-type: none"> ● Under normal conditions, no adjustment is required. <ol style="list-style-type: none"> 1. Receive a NTSC aer. broadcast. 2. Select the VCO (CW) mode from the SERVICE MENU. 3. Confirm the color change (yellow) from 「HIGH LEVEL」 to 「LOW LEVEL」 by CW TRANSF. and “SYNC : YES” being shown on the screen. Then, adjust CW TRANSF. until 「REFERENCE LEVEL」 mark turns yellow and confirm again “ SYNC : YES” being shown on the screen.

HIGH LEVEL
REFERENCE LEVEL ← YELLOW
LOW LEVEL

SYNC : YES

ADJUSTMENT OF RF AGC

Item	Measuring instrument	Test point	Adjustment part	Description
RF. AGC adjustment			No.19 RF AGC	<ol style="list-style-type: none"> 1. Receive a broadcast. 2. Select “No.19 RF AGC” of the PICTURE MODE. 3. Press the MUTE key and turn off color. 4. With the MENU LEFT key, get noise in the screen picture. (0 side of setting value) 5. Press the MENU RIGHT key and stop when noise disappears from the screen. 6. Change to other channels and make sure that there is no irregularity. 7. Press the MUTE key and get color out.

ADJUSTMENT OF FOCUS

Item	Measuring instrument	Test point	Adjustment part	Description
FOCUS adjustment	Signal generator		FOCUS VR [In HVT]	<ul style="list-style-type: none"> ● SET VIDEO STATUS to “STANDARD” <ol style="list-style-type: none"> 1. Receive a crosshatch signal. 2. While looking at the screen, adjust FOCUS VR so that the vertical and horizontal lines will be clear and in fine detail. 3. Make sure that the picture is in focus even when the screen gets darkened. <p>Note :</p> <p>The final adjustment of convergence must be done after the FOCUS adjustment. (Convergence is changed by FOCUS adjustment.)</p> <p>When makes difference by FOCUS adjustment, should be reconfirming purity adjustment.</p>

ADJUSTMENT OF DEFLECTION CIRCUIT

Item	Measuring instrument	Test point	Adjustment part	Description
<p>V.CENTER, V.SIZE and V.POSITION adjustment</p>	<p>Signal generator</p>		<p>No.14 V SIZE No.15 V CENTER V.CENTER SW (S1421)</p>	<ol style="list-style-type: none"> 1. Receive a crosshatch signal. 2. Make sure that the "No.15 V CENTER" of the PICTURE SERVICE MODE is 0. 3. Use the LEFT/RIGHT keys of the MENU to set the initial setting value for the No.14 V SIZE. 4. Adjust the vertical SCREEN size to 90% with the No.14 V SIZE and V.CENTER SW (S1421). <p>Note: Bottom of the screen is to be located within the "83%~93%" range.</p>
<p>H.WIDTH, SIDEPIN CORRECT and H.POSITION Adjustment</p>	<p>Signal generator</p>		<p>No.16 H POSITION SIDEPIN CORRECT VR H.WIDTH VR</p>	<ol style="list-style-type: none"> 1. Receive a crosshatch signal. 2. Adjust the SIDEPIN CORRECT. VR so that vertical lines at both side of the crosshatch are straight. 3. Select the "No.16 H POSITION" of the PICTURE SERVICE MODE. 4. Press the LEFT/RIGHT keys of the MENU to set the initial setting values for the "No.16 H POSITION". 5. Adjust the "No.16 H POSITION" until the screen will be horizontally centered. 6. Adjust the H.WIDTH VR so that 90% of the overall crosshatch is displayed on the screen. 7. As required, repeat above steps 2 and 6.

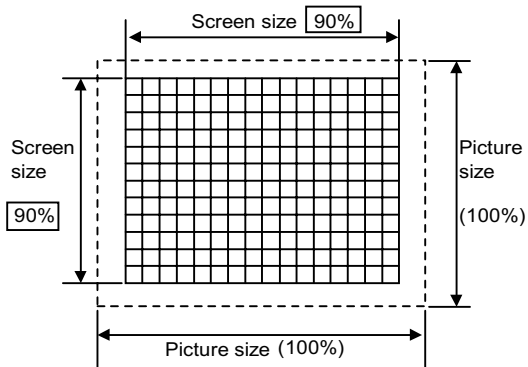

ADJUSTMENT OF VIDEO / CHROMA CIRCUIT

Item	Measuring instrument	Test point	Adjustment part	Description
<p>WHITE BALANCE (Low Light) adjustment</p>	<p>Signal generator</p>		<p>BRIGHT R CUTOFF G CUTOFF B CUTOFF SCREEN VR [In HVT]</p>	<ol style="list-style-type: none"> 1. Receive a black-and-white signal. (Color off) 2. Select the [LOW LIGHT] MODE from the SERVICE MENU. 3. Set the initial setting value of "BRIGHT" is 64. with the LEFT/RIGHT key of the remote control unit. 4. Set the initial setting value of "R CUTOFF", "G CUTOFF" and "B CUTOFF" is 20. with the ④ to ⑨ keys of the remote control unit. 5. Display a single horizontal line by pressing the ① key of the remote control unit. 6. Turn the screen VR all the way to the left. 7. Turn the screen VR gradually to the right from the left until either one of the red, blue or green colors appears faintly. 8. Adjust the two colors which did not appear until the single horizontal line that is displayed becomes white using the ④ to ⑨ keys of the remote control unit. 9. Turn the screen VR until the single horizontal line is displayed faintly. 10. Press the ② key to return to the regular screen. <p>* The ③ EXIT key is the cancel key for the WHITE BALANCE.</p>

[LOW LIGHT] MODE

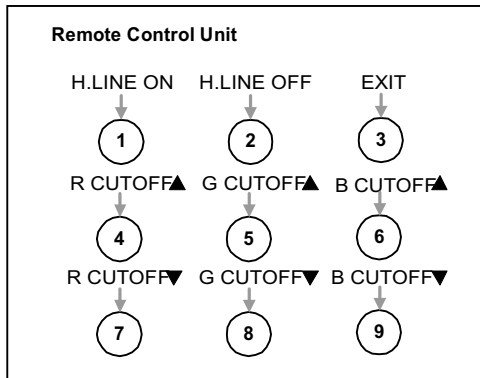
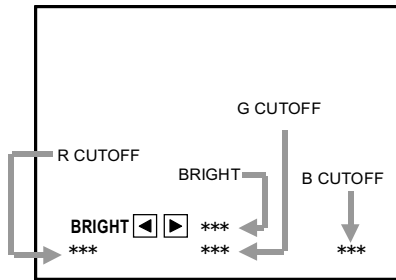

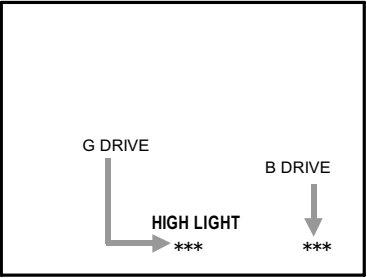
Item	Measuring instrument	Test point	Adjustment part	Description																		
WHITE BALANCE (High Light) adjustment	Signal generator		G DRIVE B DRIVE	<ol style="list-style-type: none"> 1. Receive a black-and-white signal. (Color off) 2. Select the [HIGH LIGHT] MODE in the SERVICE MENU. 3. Set the initial setting value of "G DRIVE" and "B DRIVE" with the ⑤, ⑥, ⑧ and ⑨ keys of the remote control unit. 4. Adjust the screen until it becomes white using the ⑤, ⑥, ⑧ and ⑨ keys of the remote control unit. <p>* The ③ EXIT key is the cancel key for the WHITE BALANCE.</p>																		
<div style="display: flex; justify-content: center; align-items: center; gap: 20px;"> <div style="border: 1px solid black; padding: 10px; text-align: center;"> <p>[HIGH LIGHT] MODE</p>  </div> <div style="border: 1px solid black; padding: 10px; text-align: center;"> <p>Remote Control Unit</p> <table style="width: 100%; border-collapse: collapse;"> <tr> <td style="text-align: center; padding: 5px;">H.LINE ON</td> <td style="text-align: center; padding: 5px;">H.LINE OFF</td> <td style="text-align: center; padding: 5px;">EXIT</td> </tr> <tr> <td style="text-align: center; padding: 5px;">①</td> <td style="text-align: center; padding: 5px;">②</td> <td style="text-align: center; padding: 5px;">③</td> </tr> <tr> <td style="text-align: center; padding: 5px;">↓</td> <td style="text-align: center; padding: 5px;">G DRIVE ▲</td> <td style="text-align: center; padding: 5px;">B DRIVE ▲</td> </tr> <tr> <td style="text-align: center; padding: 5px;">④</td> <td style="text-align: center; padding: 5px;">⑤</td> <td style="text-align: center; padding: 5px;">⑥</td> </tr> <tr> <td style="text-align: center; padding: 5px;">↓</td> <td style="text-align: center; padding: 5px;">G DRIVE ▼</td> <td style="text-align: center; padding: 5px;">B DRIVE ▼</td> </tr> <tr> <td style="text-align: center; padding: 5px;">⑦</td> <td style="text-align: center; padding: 5px;">⑧</td> <td style="text-align: center; padding: 5px;">⑨</td> </tr> </table> </div> </div>					H.LINE ON	H.LINE OFF	EXIT	①	②	③	↓	G DRIVE ▲	B DRIVE ▲	④	⑤	⑥	↓	G DRIVE ▼	B DRIVE ▼	⑦	⑧	⑨
H.LINE ON	H.LINE OFF	EXIT																				
①	②	③																				
↓	G DRIVE ▲	B DRIVE ▲																				
④	⑤	⑥																				
↓	G DRIVE ▼	B DRIVE ▼																				
⑦	⑧	⑨																				
SUB BRIGHT adjustment	Remote control unit		No.1 BRIGHT	<ol style="list-style-type: none"> 1. Receive a broadcast. 2. Select "No.1 BRIGHT" of the PICTURE MODE. 3. Set the initial setting value of the "No.1 BRIGHT" with the LEFT/RIGHT key of the MENU. 4. If the brightness is not the best with the initial setting value, make fine adjustment of the "No.1 BRIGHT" until you get the optimum brightness. 																		
SUB CONTRAST adjustment	Remote control unit		No.2 PICTURE	<ol style="list-style-type: none"> 1. Receive a broadcast. 2. Select "No.2 PICTURE" of the PICTURE MODE. 3. Set the initial setting value of the "No.2 PICTURE" with the LEFT/RIGHT key of the MENU. 4. If the contrast is not the best with the initial setting value, make fine adjustment of the "No.2 PICTURE" until you get the optimum contrast. 																		

Item	Measuring instrument	Test point	Adjustment part	Description	
SUB COLOR adjustment	Signal generator Oscilloscope Remote control unit	TP-B TP-E(↕) [CRT SOCKET PWB]	No.7 COLOR	<p>[Method of adjustment without measuring instrument]</p> <ol style="list-style-type: none"> 1. Receive a broadcast. 2. Select "No.7 COLOR" of the PICTURE MODE. 3. Set the initial setting value of the "No.7 COLOR" with the LEFT/RIGHT key of the MENU. 4. If the color is not the best with the Initial setting value, make fine adjustment of the "No.7 COLOR" until you get the optimum color. <hr/> <p>[Method of adjustment using measuring instrument]</p> <ol style="list-style-type: none"> 1. Input the full field color bar signal (75% white). 2. Select "No.7 COLOR" to the PICTURE MODE. 3. Set the initial setting value of the "No.7. COLOR" with the LEFT/RIGHT key of the MENU. 4. Connect the oscilloscope between TP-B and TP-E. 5. Adjust COLOR and bring the value of (A) in the illustration to the voltage +1V (V_{W-B}). 	
	SUB TINT adjustment	Signal generator Oscilloscope Remote control unit	TP-B TP-E(↕) [CRT SOCKET PWB]	No.6 TINT	<p>[Method of adjustment without measuring instrument]</p> <ol style="list-style-type: none"> 1. Receive a broadcast. 2. Select "No.6 TINT" of the PICTURE MODE. 3. Set the initial setting value of the "No.6 TINT" with the LEFT/RIGHT key of the MENU. 4. If the tint is not the best with the initial setting value, make fine adjustment of the "No.6 TINT" until you get the optimum tint. <hr/> <p>[Method of adjustment using measuring instrument]</p> <ol style="list-style-type: none"> 1. Input the full field color bar signal (75% white). 2. Select "No.6 TINT" to the PICTURE MODE. 3. Set the initial setting value of the "No.6 TINT" with the LEFT/RIGHT key to the MENU. 4. Connect the oscilloscope between TP-B and TP-E. 5. Adjust TINT and bring the value of (B) in the illustration to the voltage +0V (V_{W-Mg}).

ADJUSTMENT OF MTS CIRCUIT

Item	Measuring instrument	Test point	Adjustment part	Description
MTS INPUT LEVEL check			No.4 IN LEVEL	<ol style="list-style-type: none"> 1. Select the "No.4 IN LEVEL" of the SOUND MODE. 2. Verify that the "No.4 IN LEVEL" is set at its initial setting value.
MTS STEREO VCO adjustment	Signal generator Frequency counter	【MPX】 Connector 【2】 pin RTV [AV SELECTOR PWB]	No.5 FH MONITOR No.6 STEREO VCO	<ol style="list-style-type: none"> 1. Receive a RF signal (nonmodulated sound signal) from the antenna terminal. 2. Select the "No.5 FH MONITOR" of SOUND MODE, and change the setting value from 0 to 1. 3. Connect the Frequency Counter to pin 【2】 of 【MPX】 connector. 4. Select the "No.6 STEREO VCO". 5. Set the initial setting value of the "No.6 STEREO VCO" with the LEFT/RIGHT key of the menu. 6. Adjust the "No.6 STEREO VCO" so that the Frequency Counter will display $15.73\text{kHz} \pm 0.1\text{kHz}$. 7. Select the "No.5 FH MONITOR" of the SOUND MODE, and reset the setting value from 1 to 0.

Item	Measuring instrument	Test point	Adjustment part	Description
MTS SAP VCO adjustment	Signal generator Frequency counter	【MPX】 Connector 【4】 pin SDA 【3】 pin GND 【2】 pin RTV [AV SELECTOR PWB]	No.11 5FH MON. No.12 SAP VCO	<ol style="list-style-type: none"> 1. Receive a RF signal (non-modulated sound signal) from the antenna terminal. 2. Connect between pin 【4】 of 【MPX】 connector and GND (Pin 【3】 of 【MPX】 connector) through 1MΩ Resistor. 3. Select the “No.11 5FH MON.” of the SOUND MODE, and reset the1 setting value from 0 to 1. 4. Connect the Frequency counter to pin 【2】 (R.OUT) of 【MPX】 connector. 5. Select the “No.12 SAP VCO”. 6. Set the initial setting value of “No.12 SAP VCO” with the LEFT/RIGHT key of the menu. 7. Adjust the “No.12 SAP VCO” so that the Frequency Counter will display 78.67kHz±0.5kHz. 8. Select the “No.11 5FH MON.” of the SOUND MODE, and reset the setting value from 1 to 0.
MTS FILTER check			No.8 FILTER	<ol style="list-style-type: none"> 1. Select the “No.8 FILTER” of the SOUND MODE. 2. Verify that the “No.8 FILTER” is set at its initial setting value.
MTS SEPARATION adjustment	TV audio multiplex signal generator Oscilloscope	【MPX】 Connector 【1】 pin LTV 【2】 pin RTV [AV SELECTOR PWB]	No.9 LOW SEP. No.10 HI SEP.	Menu “MTS” is set to “STEREO”. <ol style="list-style-type: none"> 1. Input a stereo L signal (300Hz) from the TV audio multiplex signal generator to the antenna terminal. 2. Connect an oscilloscope to pin 【1】 (L OUT) of 【MPX】 connector, and display one cycle portion of the 300Hz signal. 3. Change the connection of the oscilloscope to pin 【2】 (R OUT) of 【MPX】 connector, and enlarge the voltage axis. 4. Select the “No.9 LOW SEP.” of the SOUND MODE. 5. Set the initial setting value of the “No.9 LOW SEP.” with the LEFT/RIGHT key of the menu. 6. Adjust the “No.9 LOW SEP.” so that the stroke element of the 300Hz signal will become minimum. 7. Change the signal to 3kHz, and similarly adjust the “No.10 HI SEP.”.

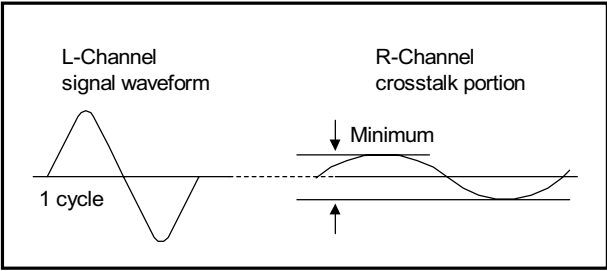

SELF CHECK FUNCTIONS

1. Outline

This model has self check functions given below. When a malfunction has been detected, the POWER is turned off and the LED flashes to inform of the failure. The malfunction is detected by the signal input state of the control line connected to the microcomputer.

2. Self check items

Check item	Details of detection	Method of detection	State of malfunction
Over-current protection (HAZARD)	Operation of B1 protector circuit.	The microcomputer detects at 1 second intervals. If NG is detected for more than 1 ms, a malfunction is interpreted.	When a malfunction has been detected, the POWER is turned off. While the POWER is being turned off, the power key of the remote controller is not operational until the power code is taken out and put in again.

3. Self check indicating function

The self-check function begins detection about 5 seconds after power is supplied.

In the event a malfunction is detected, the power is cut off immediately.

At this time, the ON-TIMER LED flashes to inform of the malfunction.

[ON-TIMER LED indication]

The ON-TIMER LED flashes at 0.5 seconds intervals.

